

See price list for available finishes (finish chart is on the order form)

Adam Rite Hookbolt Deadbolt



- Uses standard mortise cylinders.
- Case Size: 1 "x 6"
- Bolt: 5/8"x 1-3/8"x13/16" throw.
- Faceplate: 6-7/8"x 1" flat.
- Strike: Optional.
- Steel, plated.

Models	Backset
003-MS1850S150 628	7/8"
003-MS1850S250 628	31/32"
003-MS1850S350 628	1-1/8"
003-MS1850S450 628	1-1/2"

Adams Rite Exit Indicator



- Provides notification of "locked" or "open" condition.
- Compatible with MS1850S.

Model
003-4089 00 130

Adams Rite Cylinder Pulls



Models	Description
003-4025 05 01 130	Schlage C keyway
003-4025 06 01 130	Weiser keyway

Adams Rite 1000 Turns



Models	Description
003-1000 11 16 628	Parallel
003-1000 21 32 626	Perpendicular

Adams Rite Bottom Rail Deadbolt

Function: Using the same overcenter/pivot locking mechanism as the basic MS deadbolt the MS1861 lies horizontally in the bottom rail of ultra-narrow stile doors, which have sufficient vertical space for a lock and tempered glass doors, which have no stile at all.

Models
003-MS1861-01
003-MS1861-02

003-MS1861-01

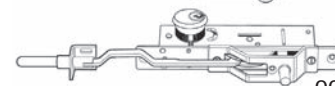
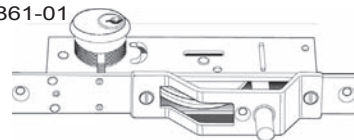

003-MS1861-02

Conversion Kit:

To convert MS186-01 to MS1861-02. Kit 4014 provides horizontal bolt assembly with guide and attachment fittings

Model
003-4014

Adams Rite Deadlock (Not Shown)

- Backset: 1-3/4" only.
- Case: 7/8" x 3-5/8" x 2-11/16".
- Bolt: 1/2" x 1-1/2".
- Strike: 1/8" xl" x 4-11/16" with 5/8" x 1-5/8" opening.
- Faceplate: Flat 1" x 5-3/4".
- Finish: 626.

Model
003-2331 626

Adams Rite Wood Door Deadlock

- Backset: 1-3/16".
- Case: 1/2" x 4" x 1-19/32" deep.
- Faceplate: 5/8" x 4-1/2", radiused.
- Finish: Zinc (603)



Model
003-5017 603

See price list for available finishes (finish chart is on the order form)

Adams Rite
Hookbolt Deadlock & Latch

Provides three modes of door control for commercial use: (1) lock and latch bolts retracted for unrestricted entry and exit;(2) Paddle-operated latch for exit-only traffic, and (3) hookbolt for overnight lockup (Patented)

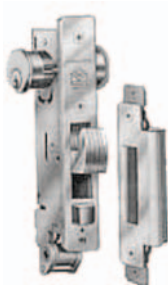

- Case size: 1" x 7 3/8"
- Lock bolt: 5/8" x 1 3/8" x 13/16" throw
- Latch bolt: 5/8" x 5/8" x 7/16" throw.
- Armor faceplate: 6 7/8" x 1" flat.
- Armored strike: furnished flat.
- Finish: clear satin anodized.
- Not compatible with electric strikes.

Models	Hand	Backset
003-MS1890 2016 628	RH/LHR	31/32"
003-MS1890 3016 628	RH/LHR	1 1/8"

Adams Rite
Deadlock

- For narrow stile sliding doors.
- Case: 1/2"x3-3/16"x 1/8".
- Bolt: anti-lift/adjustable.
- Faceplate: full radiused ends.
- Finish: US32D.



Model
003-MS1847 02 630

Adams Rite
Deadlock

For installations where the long-throw M.S. deadlock cannot be accommodated.



- Accepts standard mortise cylinders.
- Case: 27/32" x 4 1/2".
- Bolt: 5/8" x 1 1/4" x 5/8" throw.
- Armored faceplate: Flat 1" x 5 5/8".
- Finish: 628 satin aluminum

Model
003-MS4070 31/32 628

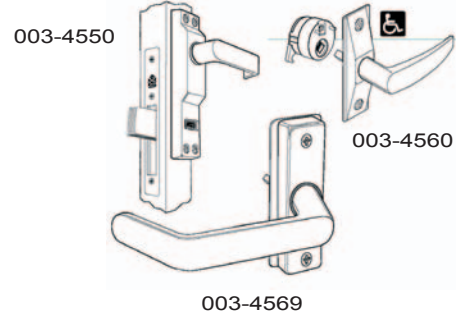

Adams Rite
Latch Handles

- 4580 cam disc included can be reversed.
- *For MS Bolts Only

Models	Finish	Hand
003-4560 601 121	121(Duro)	LH
003-4560 601 682	682(Alum)	LH
003-4569 501 682	682(Alum)	LH
003-4550 313*	313	Rev
003-4569 501 121	121 (Duro)	LH
003-4550 628*	628	Rev

See price list for available finishes (finish chart is on the order form)

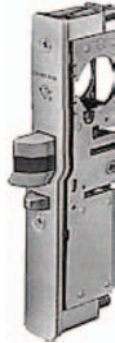

Adams Rite Series 4710 Heavy Duty Deadlocking Latch

- Provides part time exit-only traffic control.
- Accepts standard mortise cylinder.
- Case Size: 7/8"x 6-13/16"
- Bolt: 1/2"x1"x1/2" throw.

Models	Finishes	Hand	Backset
003-4710 15 628 7/8	628	LH	7/8"
003-4710 25 313 31/32	313	LH	31/32"
003-4710 26 628 31/32	628	RH	31/32"
003-4710 35 628 1 1/8	628	LH	1 1/8"
003-4710 35 313 1 1/8	313	LH	1 1/8"
003-4710 46 628 1 1/2	628	RH	1 1/2"



Adams Rite Series 4510 Deadlocking Latch

Same as 4710 without top and bottom mounting yokes.

Models	Finishes	Hand	Backset
003-4510MC25 313	313	LH	31/32"
003-4510MC25 628	628	LH	31/32"
003-4510MC35 313	313	LH	1 1/8"
003-4510MC35 628	628	LH	1 1/8"

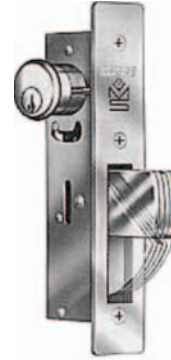

Adams Rite Series 1850S Maximum Security Deadlock

For single leaf door or installation where the gap between door and jamb is greater than it should be. Accepts standard mortise cylinder.

- Case Size: 1"x 6"
- Bolt: 5/8"x 1-3/8" throw

Models	Finishes	Backset
003-MS1850S110 628	628	7/8"
003-MS1850S210 628	628	31/32"
003-MS1850S310 628	628	1 1/8"
003-MS1850S410 628	628	1 1/2"

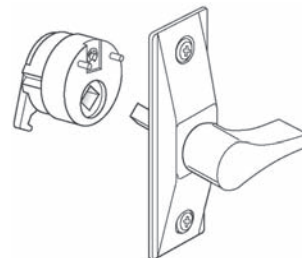

Adams Rite Deadlatch Handles

Handle

Thumbturn of minimum practical length is designed to offer a firm grip to the fingertips. Ideal for doors where latch is operated infrequently or in emergencies only. Use with Adams Rite Deadlatches

Model	Finish
003-4565	682

See price list for available finishes (finish chart is on the order form)

**Adams Rite
4590 Latch Paddles**



- All Paddles Are Now Reversible
- Push / Pull Labels Included
- 4580 Cam Disc Included - Can Be Reversed.

Models	Finish	Description
003-4590 02 00 628	628	Push to left
003-4590 02 00 313	313	Push to left
003-4590 04 00 628	628	Push to right

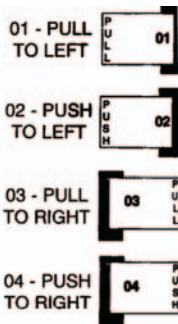

**Adams Rite
4591 Deadlatch Paddle**

- Extruded aluminum.
- Available in 4 modes: push to left, push to right, pull to left and pull to right (can be reconfigured in the field).

Models
003-4591 02 00 628
003-4591 02 00 313

**Adams Rite
For Lever Handles**



003-4580



003-26 0398

Models	Description
003-4580 501	CamPlug-LH
003-4580 601	CamPlug-RH
003-31 0485	Spindle Assy. 4160
For Paddles	
003-91 0060	Spring Rep. Kit f/4590
003-26 0398	Set Screw
003-N310 416	Pal Nut
003-26 0188 09	BinderPost

**Adams Rite
For Locks**



Models	Description
003-28 0064 02	Spring(1850A)LH
003-28 0064 03	Spring(1850A)RH
003-4104 01	MountingClip-Radius
003-4104 02	MountingClip-Flat
003-4104 03	MountingClip-LH
003-4104 04	MountingClip-RH
003-S232B8 9/32N 631	Set Screw 7/8"
003-S232C08 05 631	Set Screw 31/32"
003-S232C8 15/32 631	Set Screw 1-1/8"
003-S23355D08R04 628	Faceplate Screw
003-4501 01 630	Strike Long Stainless
003-4502 01 630	Strike Short Stainless
003-4501 01 RC121	Strike Long Duro
003-4502 01 RC121	Strike Short Duro
003-MS4002 012 628	Box Strike f/MS 1850
003-4001 012 628	Box Strike f/MS 1850 .
003-MS4043 00 603	Cylinder Guard.

**Adams Rite
Bottom Rail Deadbolt Swing Bolt**

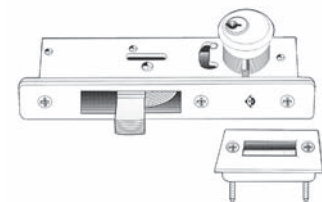

For bottom rail locking of ultra-narrow stile or tempered glass doors whose bottom rail shoe is too shallow for the MS1861. Mechanism is that of the MS1850A deadbolt, but with the bolt size reduced. This keeps the threshold strike opening to a practical minimum, avoiding collection of debris or snagging of spike-heeled shoes. Armor faceplate protects cylinder setscrews from tampering and keeps them from loosening

Models	Description
003-1830	ANSI/BHMA Type E8211 Grade 1
003-4006	Strike Plate

See price list for available finishes (finish chart is on the order form)

003-4005

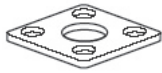

003-BOLT

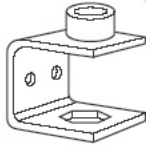

003-4015



Adams Rite Threshold Bolt

Adding the 4015 bolt to a pivoted bolt MS deadbolt allow a maximum security for pairs of doors by the turn of a single key. Simultaneously dropping a hardened steel hexbolt into the threshold and providing the massive MS bolt into the mating doors stile, the two-point lock secures the entire double door entrance. The 4015 threshold bolt is harnesses to the rear of the pivoted bolt. It may be added to any basic MS1850S or MS1850SN deadbolt.

Models	Description
003-4015	ANSI/BHMA Type E8241 Grade 1
003-Bolt41-0827-02	Bolt Guide
003-4005	Strike Plate

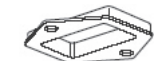

Header Strike



Rod Guide

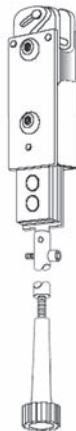

Adams Rite Header Bolt/ Pairs of Doors Only

Designed to add a top of door third locking point for pairs of doors with MS pivoted bolt and 4015 threshold bolt in the active leaf. This is a "scissors" action to center itself in its strike as it rises. this saves the key holder from the difficulty of lining up the doors with three separate strikes, even if doors are misaligned due to faulty installation or setting.

Models	Description
003-4085	ANSI/BHMA Type E8261 Grade 1
003-Ro-41-0827-02	Rod Guide
003-HS-25-0071	Header Strike

003-4780



003-8650



003-Strike



Adams Rite Two-Point Deadlatch w/Paddle

Designed for paired outswinging narrow stile glass doors but also suitable for single doors. Allows both door leaves to be "active" There is no need to pin one door with flushbolts or other devices.

Models	Description
003-4780	Two-point Deadlatch with Paddle
003-8650	Escutcheon
003-HS-25-0071	Header Strike

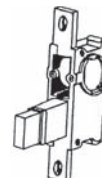

Amarlite Lock Replacement

- Exact replacement for the Amarlite Telescopic Bolt Lock
- Lock supplied less cylinders
- Cylinder holes threaded for Amerlite as well as any standard size cylinder

Model	Description
027-003607	ESAL77 Lock Replacement

See price list for available finishes (finish chart is on the order form)

Corbin Russwin
DL4000 Mortise Deadlock (Not Shown)

- Meets Fed. Spec. 190.
- 1" deadbolt w/hardened steel Inserts.
- 2 3/4" backset.

Model
018-DL4013 626LC

Iico
Garage Door Lock



- Garage Door Lock**
- 2-3/8" x 3" die cast case
 - 2" backset.

Model
037-547 54 51

Iico
Surface Mounted Rim Locks

Models	Description	
037-507 54 51	Heavy. Duty Rim Deadlock. Dbl. Cyl. Brass lacquer.	
037-220 67 41	Night Latch (Hol back function)	
037-220 67-41KA25233	Die cast cylinder -1054DL kwy.	
037-530 53 41	Jimmy Proof Lock - sgl. Cyl. Die Cast Cylinder 1054DL	
037-535 53 41	Jimmy Proof Lock. Dbl. Cyl.	
037-535 53 41-KA2	Bronze lacquer - available KA.	
037-545 54 41	Rim Deadlock - Sgl. Cyl. Die cast cyl.1054DL	

Marks
Mortise Deadlocks
2/3 Series



- Bolt-1" throw.
- Case-high-pressure cast.
- Front- 1-1/16"x4-5/8" plate.
- Reversible.
- Supplied with turnpiece only.

Models
2 series 2-1/2" backset
045-2000 26D

3 series 2-3/4" backset
045-3000 3
045-3000 26D



048-C8762 048-C8763 048-C8764



048-C8765

Freezer/Cooler Locks

- **Application** - Reversible handle mounts on edge of freezer and cooler doors. (C8762 and C8763 replacement plugs are for earlier models of C8765 locking handles (National Lock 59-1105 series).
- **Operation** - Key removable in both locked and unlocked positions. Handle can be used as latch until locked with key.
- **Keying** - Keyed alike to XC-3 - uses D8780 KB.
- **Packaging** - C8765 supplied with two keys, strike mounting plate and strike - mounting screws not furnished.

C8762 and C8763 plugs supplied with two keys and specific retainer. C8764 plug supplied with two keys, retainer/stop screw.

Models
048-C8765 26 KA
048-C8764 26
048-C8763 26
048-C8762 26

See price list for available finishes (finish chart is on the order form)



Progressive
Replacements For Lockwood
Mortise Locks and Mortise Knob Latch

- Brass front, cast iron case.
- Front: 4-1/2" x 1-1/8".
- Beveled front is reversible.
- Hub accepts standard 9/32" spindle.
- Latch bolt by knob from either side.
- 2-3/4" backset.

Model
052-1084



Progressive
Mortise Dead Lock

- All brass construction.
- Front: 4-5/8" x 1-1/16".
- Bolts extends full 1".
- Backset: 2-3/4".
- Operates by cylinder or turn.
- Accepts standard mortise cylinder.
- Depth of case: 3-3/4".
- Height of case: 3".
- *Available in US4 Or US26D front.

Model
052-229109



Progressive
Replacement for 053-2214
Lockwood Cylinder Dead Lock

- Solid brass front (4-1/8" x 1-1/16") and deadbolt.
- Cast iron case.
- 2-3/4" backset.
- Uses standard mortise cylinder.

Model
052-2214



Progressive
Mortise Dead Latch

- All brass construction.
- Front: 4-7/8" x 1-1/4".
- Hub accepts 9/32" spindle.
- Uses standard mortise cylinder.
- Hold in button for latch.
- Operate latch by knob or cylinder.
- Replacement for Lockwood Mortise Locks

Model
052-1210

See price list for available finishes (finish chart is on the order form)



**Rockwood
Secret Gate Latch**

- **Material:** Cast Brass
- **Finishes:** US4, US10, US10B, US26D
- **Strike:** 2" x 2-3/4"
- **Case:** 2" x 2-3/8"
- Single acting, reversible. Supplied with dummy knob.
- Bolt activated by pressing button concealed on bottom of latch case.

Model	Description
057-602	Fastener - #7 x 1/4 OH WS

**Yale
Rim Locks**

#80 Pin Tumbler Latchlock
17/32" throw. 2-3/8" b.s.
3-5/8"W x 2- 1/2"H.

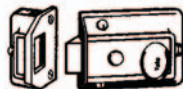

Model
078-80

#112 Pin Tumbler Boltlock
1-1/8" throw; 2-3/8" b.s.
3-1/2"W x 3-1/16"H.

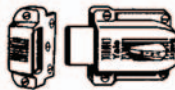

Models	Description
078-112	112 Standard
078-112F	112F w/Flat Strike
078-112-1/4	112 - 1/4 Dbl. Cyl

#197 Pin Tumbler Jimmyproof
2-3/8" B.S.; 4-3/4"W x 3-5/32"H.

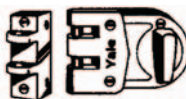

Models	Description
078-197	197 Standard
078-1971/4	197 - 1/4 Double Cylinder

022-PDL100



022-PDL101

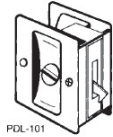

Pocket Door Locks

- Field reversible.
- Adjustable for various door thickness.
- Includes pin and screws for 1-3/4" door width.
- Finishes: 605, 609, 613, 619, 620, 622, 625, 626

Models	Description	Size	ANSI
022-PDL100	Passage	2-1/2" x 2-3/4"	D0821
022-PDIL101	Privacy	2-1/2" x 2-3/4"	D0831



044-869



044-861U



044-861B



044-861C

Accessory Collars

Spacing Collars		
Models	Description	Finish
044-861C2810-000	3/32"	28
044-861 E03 10-000	5/32"	3
044-861E2810 -000	5/32"	28
044-861E4610-000	5/32"	79
044-861F2810-000	1/4"	28
044-861F4610 -000	1/4"	79
044-861KOO 10-000	3/16"	Vinyl
044-861Q2810-000	3/8"	28
Tapered Hardened Cylinder Collars - 5/16" Projection		
044-861W0310-000	5/16"	3
044-861W 10-000	5/16"	Nickel
044-861W1410-000	5/16"	79
Adjustable Collars 5/16" to 15/32"		
044-861U0310-000		3
044-861U26 10-000		260
Cams		
044-869-0010	Cash Box Nut	