

See price list for available finishes (finish chart is on the order form)



046-6270



046-770

## Master Lock 6270 Solid Steel Shackleless Round Padlock and 770 Security Hasp

- Padlock 2-7/8" round body
- Available cylinders: W6000 5-pin, W7000 6-pin, AM W600A 5-pin, AM W700A 6-pin

Models
046-6270
046-770



046-420



046-421

## Master Lock Safety Lockout System

- Assure positive worker protection for electric, gas, water, steam, acid, pneumatic and machine systems
- Lockout accepts six padlock - meets all ANSI safety standards
- Choice of six padlocks bumper colors for coding systems by work team or department
- Durable brass tags positively identify padlocks by individual worker.
- Vinyl coated high-tensile steel - plated to resist rust
- Accepts six padlocks up to 11/32" shackle diameter.

Models	Description
046-420	1" dia. jaws,
046-421	1-1/2" dia jaws

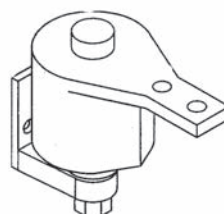
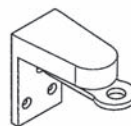

## Bommer Spring Pivot Non-Adjustable Spring Tension

- Cast steel base.
- Double acting.
- Ball bearing.
- Non-adjustable spring tension.
- Non-handed.
- Maximum doors size and weight.  
Width - 36".  
Thickness - 2 1/2".  
Weight -75 lbs.
- Flat door bracket.
- For doors not less than 1" thick.
- Flat jamb bracket - 1 1/4" wide.
- Standard packaging per box.
  - (1) Pivot.
  - (1) Ea. Jamb & door bracket.
  - (1) 7890 Top pivot assembly with jamb bracket.
  - (8) No. 12 X 1 1/4" flat head wood screws.
  - (2) No.10 X 1" flat head wood screws.
- (8) Pivots per case.

Model	Description
080-7012	Surface Pivot

See price list for available finishes (finish chart is on the order form)

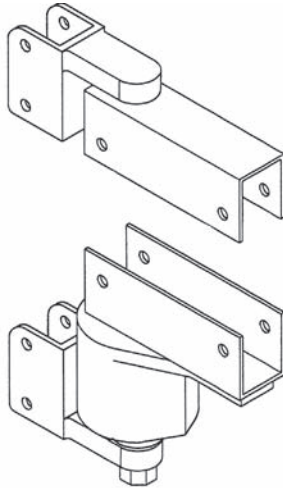

## **Bommer** Surface Pivot Adjustable Spring Tension

- Box clamp door bracket.
- Box clamp jamb bracket.
- Brass.
- Ball bearing.
- Double acting.
- Adjustable spring tension.
- Non-handed.
- Maximum door size and weight.  
Width - 36".  
Thickness-2 1/2".  
Weight -75 lbs.
- Flat door bracket, for doors not less than 1" thick.
- Flat jamb bracket - 1 1/4" wide.
- Box clamp jamb bracket for 1 1/8" and 1 1/4" thick jambs only.
- Box clamp door bracket for 1 1/8" thick doors only.
- Standard packaging per box.
  - (1) Pivot.
  - (1) Ea. Jamb & door bracket.
  - (1) Top pivot assembly with jamb bracket.
  - (8) No. 12 X 1 1/4" flat head wood screws.
  - (2) No.10 X 1" flat head wood screws.
  - (4) Thru-bolts and nuts.
- (8) Pivots per case.

Model	Description
080-7313	Surface Pivot

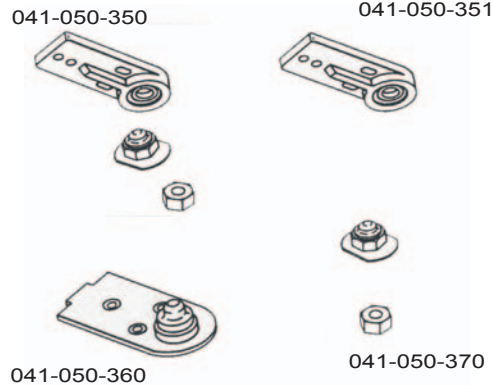

## **Kawneer** Bottom Center Pivot

The low profile center pivot for use with a threshold has an adjustable stainless steel pivot pin that is mounted and locked into the threshold. The center pivot for use without a threshold has a stainless steel pivot pin press fit into a stainless steel plate. The door portion is comprised of a roller bearing press fit into a cast aluminum pivot block.

**Application:** Both pivot portions, with or without threshold, are used on doors with concealed overhead closer control. On entrances with thresholds the pivot is anchored securely into the threshold. The frame portion is adjustable for proper door and frame clearance. The frame portion for use on doors without threshold is fastened directly to the floor. When no threshold is used, height adjustment is obtained by shimming the pivot block. The door pivot block is securely mounted to the bottom rail web.

**Finish:** Mill finish is standard for all bottom center pivot parts.

Models	Description
041-050-350	Door & Frame Portion for use with Threshold
041-050-351	Door Portion for use with Threshold
041-050-360	Frame Portion for use with Threshold
041-050-370	Frame Portion for use with out Threshold

See price list for available finishes (finish chart is on the order form)

### Kawneer Top Offset Pivot

Both the door and frame portion of the pivot assembly are of cast aluminum. Press fitted into the frame portion is a heavy wall oilite bronze self-lubricating bearing. A stainless steel pivot pin in the door portion completes the assembly.

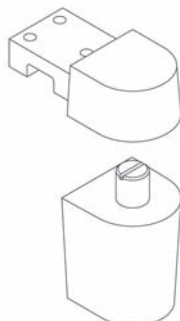

041-050-322

**Application:** The frame portion is mortised into the header/transom bar and is attached with screws threaded into the pivot block. The pivot attachment location takes advantage of the strength at the frame joint. The door portion has two bosses which interlock in the door extrusion, to prevent rotation. It is secured in place with two screws through a reinforcing plate which spreads the load. The spring loaded pivot pin allows easy "one man" installation.

**Finish:** Standard finish is a thermosetting polyester powder coated finish applied to match anodized finishes of #17 Clear, #40 Bronze and #29 Black. Other finishes available upon request.

Models	Description
041-050-322	Top Offset Pivot Package
041-035-525	For Doors Manufactured before 4-3-89
041-041-927	Top Pivot Frame Portion for SAM 11
041-118-400	Top Pivot Frame Portion for Tuffline Doors
041-118-401	Top Pivot Door Portion for Tuffline Doors

### Kawneer Bottom Offset Pivot

Door Portion - is of cast aluminum. Attachment is obtained by back bolting through a plated steel reinforcing plate, the door stile extrusion and threading into the pivot block. A ball-bearing raceway accepts the pivot pin. The door portion provides vertical screw adjustment to achieve proper door, frame, and threshold clearance. Frame Portion (with threshold) the pivot base is of cast aluminum



041-050-326  
041-050-327



041-035-506

with a steel pivot pin. This pivot portion becomes an integral part of the door frame and securely anchors the frame and threshold to the floor. Floor Portion - (without threshold) the pivot plate is stainless steel with a riveted stainless pivot pin. The plate is fastened at three points directly to the floor.

**Application:** The bottom offset pivot is used in conjunction with the top, and optional intermediate offset pivot. The frame portion is used with threshold. On interior or vestibule door not requiring threshold the floor mounted portion is used. The door portion provides vertical adjustment with both pivot pieces.

**Finish:** Standard finish is a thermosetting polyester powder coated finish applied to match anodized finishes of #17 Clear, #40 Bronze and #29 Black. Other finishes available upon request. Contact the factory. The floor portion is a clear finish to match the threshold or stainless steel door without threshold.

Models	Description
041-118-409	Bottom Pivot Door Portion for Tuffline Door
041-118-411	Bottom Pivot Frame Portion for Tuffline Door
041-050-326	(RH) Bottom Pivot Door Frame Portion for use with Threshold
041-050-327	(LH) Bottom Pivot Door Frame Portion for use with Threshold
041-035-506	Bottom Pivot Frame Portion for use without Threshold

See price list for available finishes (finish chart is on the order form)

## Kawneer Standard Intermediate Pivot

This aluminum die cast pivot is adjustable and load bearing with the extra benefit of being non handed. The door portion is surface applied with two screws and intragal interlocking boss which resist both rotational and thrust loads. The frame portion is mortised into the frame with just two screws for attachment. The pivot pin is stainless steel which works within a heavy wall, self lubricated oilite bearing. It is also available in electric transfer model.

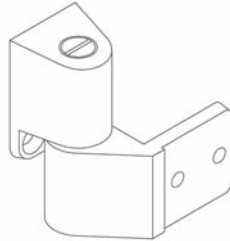

041-050-331

**Application:** This pivot is used in conjunction with top and bottom offset pivots for additional strength and door/frame alignment. Use of this pivot is advised on doors experiencing high traffic volume or on doors exceeding 7'-6" (2286) in height. (not for top pivot replacement)

**Finish:** Standard finish is a thermosetting polyester powder coated finish applied to match anodized finishes of #17 Clear, #40 Bronze and #29 Black. Other finishes available upon request. Contact the factory.

Models	Description
041-050-331	Intermediate Offset Pivot Package
041-118-403	Frame Portion for Tuffline Door
041-118-405	Door Portion for Tuffline Door
041-105-162	Offset Pivot set (LH) for Entara Door
041-105-163	Offset Pivot set (RH) for Entara Door

## Kawneer Top Center Pivot

The "walking beam" frame pivot portion is cast aluminum with a hardened steel pivot pin. The pin is adjustable for additional extension through the transom bar/header. Both door pivot portions are machined aluminum with oilite bronze self-lubricating bearings. All top center hung pivot parts are concealed.

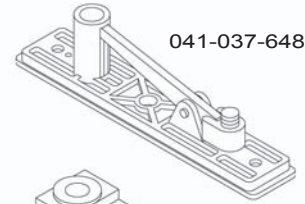

041-037-648

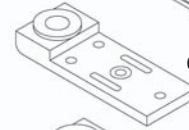

041-037-942

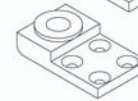

041-037-823

**Application:** This pivot assembly is used in conjunction with center hung doors with floor closers. The adjustable portion for the 190 Narrow Stile Door provides for a one time only adjustment. Dimension 3" (76.2) long, 1-7/16" (36.5) wide, and 1/2" (12.7) at its thickest point. The 350 Medium Stile and 500 Wide Stile door pivot portion is non-adjustable. Dimensions 2-3/8" (60.3) long, 1-7/16" (35.5) wide and 1/2" (12.7) at its thickest point.

**Finish:** The frame portion is natural cast aluminum with dress plate to match color of frame. The machined door portion is mill finish.

Models	Description
041-037-823	Top Center Pivot Package Door Portions for 350/500 Doors
041-037-648	Walking Beam Top Pivot
041-037-942	Adjustable Top Center Pivot Package Door Portion for 190°Doors

See price list for available finishes (finish chart is on the order form)

**Ives**  
**7200 Series Pivot Selection Chart**

Pivot Set	UL Rating	Top Pivot	Bottom Pivot	Bottom Pivot Mounting	Recom. Intermediate Pivot	Position	Max Door Weight	Handed
038-7212	None	7212-7215-7222-7226-7227 TOP	7212 BTM	Jamb Mounted	7212-7212V-7222 INT	3/4" Offset	200	Yes
038-7212V	None	7212V TOP	7212 BTM	Jamb Mounted	7212-7212V-7222 INT	3/4" Offset	200	Yes
038-7215	20 min	7212-7215-7222-7226-7227 TOP	7215 BTM	Jamb Mounted	7215-7226-7227 INT	3/4" Offset	500	Yes
038-7215F	3 hr	7215F-7226F-7227F TOP	7215F BTM	Jamb Mounted	7215F-7226F-7227F INT	3/4" Offset	500	Yes
038-7222	None	7212-7215-7222-7226-7227 TOP	7222 BTM	Floor Mounted	7212-7212V-7222 INT	3/4" Offset	200	Yes
038-7226	20 min	7212-7215-7222-7226-7227 TOP	7226 BTM	Floor Mounted	7215-7226-7227 INT	3/4" Offset	600	No
038-7226F	3 hr	7215F-7226F-7227F TOP	7226F BTM	Floor Mounted	7215F-7226F-7227F INT	3/4" Offset	600	No
038-7227	20 min	7212-7215-7222-7226-7227 TOP	7227 BTM	Mortised Cement Case	7215-7226-7227 NT	3/4" Offset	700	No
038-7227F	3 hr	7215F-7226F-7227F TOP	7227F BTM	Mortised Cement Case	7215F-7226F-7227F INT	3/4" Offset	700	No
038-7230F	3 hr	7230F-7237F TOP	7230F BTM	Floor Mounted	7230F-7237F INT	3/4" Offset	1000	No
038-7237F	3 hr	7230F-7237F TOP	7237F BTM	Mortised Cement Case	7230F-7237F INT	3/4" Offset	1750	No
038-7244F	3 hr	7244F-7245F TOP	7244F BTM	Floor Mounted	7244F-7245F INT	1-1/2" Offset	400	No
038-7245F	3 hr	7244F-7245F TOP	7245F BTM	Mortised Cement Case	7244F-7245F INT	1-1/2" Offset	500	No
038-7253	None	7253-7255-7255J-7256 TOP	7253 BTM	Floor Mounted	None	Center Hung	300	No
038-7255	None	7253-7255-7255J-7256 TOP	7255 BTM	Floor Mounted	None	Center Hung	500	No
038-7255J	None	7253-7255-7255J-7256 TOP	7255J BTM	Jamb Mounted	None	Center Hung	500	No
038-7256	None	7253-7255-7255J-7256 TOP	7256 BTM	Mortised Cement Case	None	Center Hung	600	No
038-7259	None	7259 TOP	7259 BTM	Mortised Cement Case	None	Center Hung	1000	No

See price list for available finishes (finish chart is on the order form)

## Ives- 7200 Series Pivots Fire Rated - 400 - 500 lb. Doors 1-1/2 Offset Pivots

038-7244F, 038-7245F  
Top Pivot

**038-7244F Pivot Set**

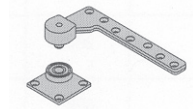

038-7224F Bottom Pivot

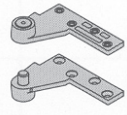

**038-7245F Pivot Set**

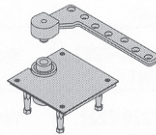

038-7245F Bottom Pivot

Optional

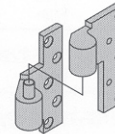

038-7244F, 038-7245F  
Intermediate Pivot

## Ives- 7200 Series Pivots Center Hung Pivots - 300 to 600 lb. Doors

038-7253, 038-7255, 038-7255J, 038-7256 Top Pivot

**038-7253  
Pivot Set**

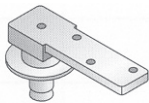

038-7253 Bottom Pivot

**038-7255  
Pivot Set**

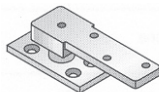

038-7255 Bottom Pivot

**038-7255J  
Pivot Set**

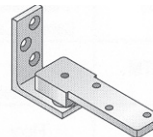

038-7255J Bottom Pivot

**038-7256  
Pivot Set**

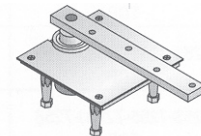

038-7256 Bottom Pivot

## Ives - 7200 Series Pivots Center Hung Pivots - 1000 lb. Doors

038-7259 Top Pivot

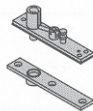

**038-7259 Pivot Set**

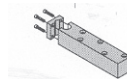

038-7259 Bottom Pivot



See price list for available finishes (finish chart is on the order form)

**Ives-7200 Series Pivots**

**3/4" Offset Pivot - 200 lb. Doors**

038-7212, 038-7215, 038-7222, 038-7226, 038-7227 Top Pivot

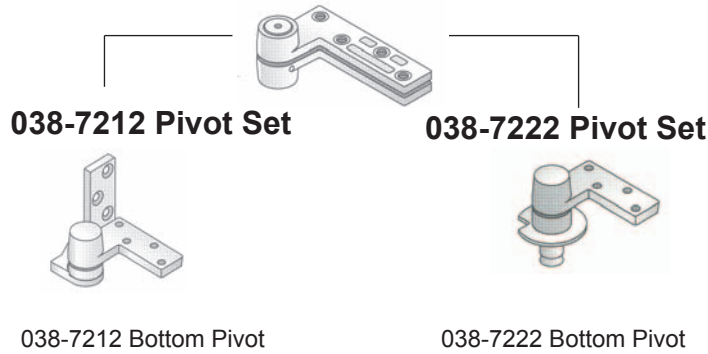

038-7212V Top Pivot

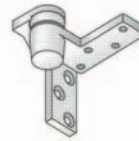

**038-7212V  
Pivot Set**

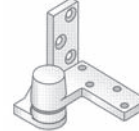

038-7212 Bottom Pivot

Optional

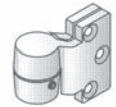

038-7212, 038-7212V,  
038-7222  
Intermediate Pivot

**Ives - 7200 Series Pivots**

**3/4" Offset Pivot - Standard & Fire Rated - 500 lb. to 700 lb. Doors**

038-7212, 038-7215, 038-7226, 038-7227 Top Pivot, 038-7222  
038-7215F, 038-7226F, 038-7227F Top Pivot

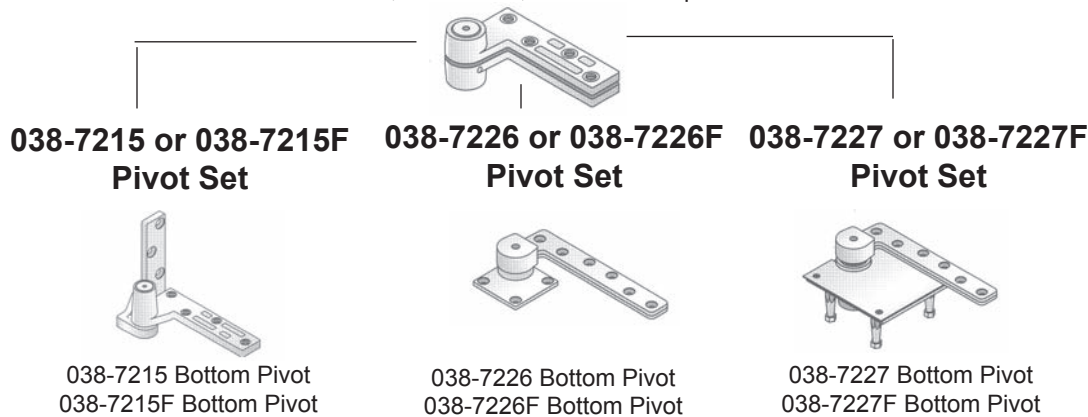

Optional

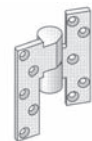

038-7215, 038-7226,  
038-7227  
Intermediate Pivot  
038-7215F, 038-7226F,  
038-7227F  
Intermediate Pivot

**Ives - 7200 Series Pivots**

**3/4" Offset Pivot - Fire Rated - 1000 lb. to 1750 lb. Doors**

038-7230F, 038-7237F Top Pivot

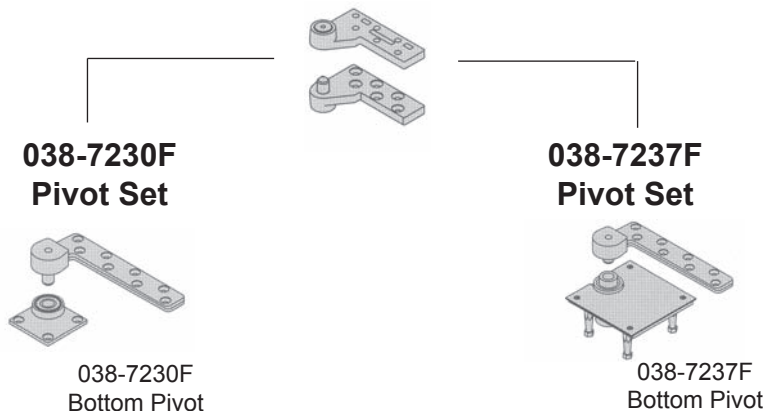

Optional

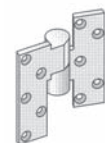

038-7230F, 038-7237F  
Intermediate Pivot